

# NPort® IA5000A Series

*1, 2, and 4-port serial device servers for industrial automation*



- > Enhanced surge protection for serial, LAN, and power
- > 2 KV isolation for serial signals
- > Rugged screw-type terminal blocks for power and serial connectors
- > C1D2 and ATEX certified for harsh industrial environments
- > Cascading Ethernet ports for easy wiring
- > Redundant DC power inputs
- > Warning by relay output and email
- > Low power consumption with built-in MiiNe CPU
- > Wide-temperature from -40 to 75°C



## Overview

The NPort IA5000A series device servers are designed for connecting industrial automation serial devices, such as PLCs, sensors, meters, motors, drives, barcode readers, and operator displays. The device servers are ultra rugged with a metal housing, screw connectors, and

full surge protection. The NPort IA5000A series device servers are extremely user-friendly, making simple and reliable serial to Ethernet solutions possible.

## Cascading Ethernet Ports Make Wiring Easy (10/100BaseTX models only)

The NPort IA5000A series device servers each have two Ethernet ports that can be used as Ethernet switch ports. One port connects directly to the network or server, and the other port can be connected to another NPort IA device server or another Ethernet device. The dual Ethernet ports help reduce wiring costs by eliminating the need to connect each device to a separate Ethernet switch.

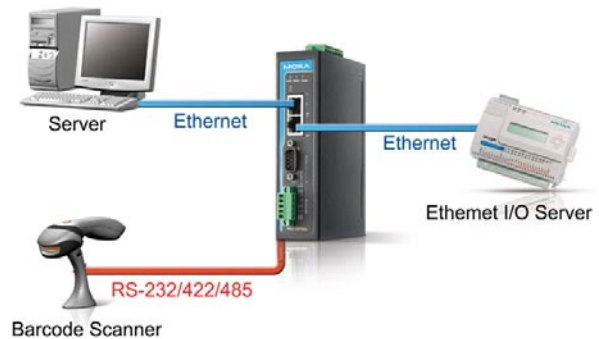

## Redundant Power Inputs

The NPort IA5000A series device servers have two power inputs that can be connected simultaneously to live DC power sources. If one power source fails, the other source takes over automatically. Redundant power inputs help ensure that your device server will operate non-stop.

## Dual Power Inputs

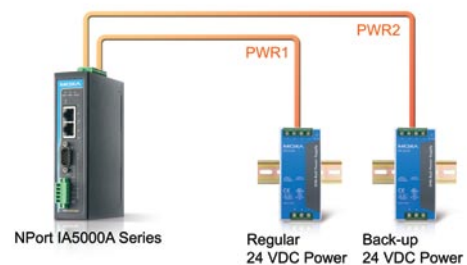

## Relay Output Warning and E-mail Alerts

The built-in relay output can be used to alert administrators when the Ethernet is down, when problems with the power inputs arise, or when there is a change in the DCD or DSR serial signals. An e-mail warning can also be issued when an exception is detected. These functions are valuable tools that enable maintenance engineers to react promptly to emergency situations.

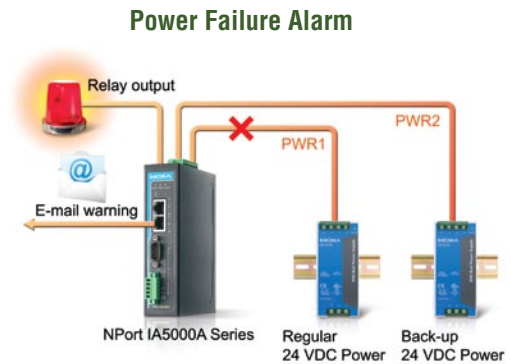

## Surge Protection for Serial, LAN, and Power

Moxa's leading-edge surge immunity solution, which is applied to the NPort® IA5000A's serial, power, and Ethernet lines, is tested and proven compliant with IEC 61000-4-5. This state-of-the-art surge protection provides a robust serial-to-Ethernet solution that can

protect electrical devices from voltage spikes and withstand electrically noisy environmental conditions, such as oil and gas, and power automation applications.

## Industrial-grade Certification

To ensure safe and reliable operation in industrial environments, the NPort® IA5000A device servers have obtained various industrial certifications, including an IP30 rating for mechanical protection and UL508 safety certification for industrial control equipment. In addition,

these device servers are UL/cUL Class 1 Division 2 Groups A, B, C, D certified for explosion-safe usage, and with ATEX Class 1 Zone 2 certification, are suitable for use in hazardous locations.

## Specifications

### Ethernet Interface

**Number of Ports:** 2  
**Speed:** 10/100 Mbps, auto MDI/MDIX  
**Connector:** 8-pin RJ45  
**Magnetic Isolation Protection:** 1.5 kV built-in  
**Ethernet Line Protection:** 1 kV (level 2) surge protection

### Serial Interface

**Number of Ports:**  
 NPort IA5150A: 1  
 NPort IA5250A: 2  
 NPort IA5450A: 4  
**Serial Standards:** RS-232/422/485  
**Connector:**  
 NPort IA5150A: DB9 for RS-232, terminal block for RS-422/485  
 NPort IA5250A/IA5450A: DB9 for RS-232/422/485

### Serial Line Protection:

- 15 kV ESD protection for all signals
- 2 kV isolation protection for isolation models
- 1 kV (level 2) surge protection

**RS-485 Data Direction Control:** ADDC® (automatic data direction control)

### Serial Communication Parameters

**Data Bits:** 5, 6, 7, 8  
**Stop Bits:** 1, 1.5, 2  
**Parity:** None, Even, Odd, Space, Mark  
**Flow Control:** RTS/CTS and DTR/DSR (RS-232 only), XON/XOFF  
**Baudrate:** 50 to 921.6 Kbps

### Serial Signals

**RS-232:** TxD, RxD, RTS, CTS, DTR, DSR, DCD, GND

**RS-422:** Tx+, Tx-, Rx+, Rx-, GND  
**RS-485-4w:** Tx+, Tx-, Rx+, Rx-, GND  
**RS-485-2w:** Data+, Data-, GND

### Software

**Network Protocols:** ICMP, IP, TCP, UDP, DHCP, BOOTP, Telnet, Rtelnet, DNS, SNMP, HTTP, SMTP, SNTIP, IGMP

**Configuration Options:** Web Console, Serial Console, Telnet Console, Windows Utility

**Windows Real COM Drivers:** Windows 95/98/ME/NT/2000, Windows XP/2003/Vista/2008/7 x86/x64

**Fixed TTY Drivers:** SCO Unix, SCO OpenServer, UnixWare 7, UnixWare 2.1, SVR 4.2, QNX 4.25, QNX 6, Solaris 10, FreeBSD, AIX 5.x, HP-UX 11i

**Linux Real TTY Drivers:** Linux kernel 2.4.x, 2.6.x

### Physical Characteristics

**Housing:** Metal

### Weight:

NPort IA5150A: 475 g  
 NPort IA5250A: 485 g  
 NPort IA5450A: 560 g

### Dimensions:

NPort IA5150A/IA5250A: 36 x 105 x 140 mm (1.42 x 4.13 x 5.51 in)  
 NPort IA5450A: 45.8 x 134 x 105 mm (1.8 x 5.28 x 4.13 in)

### Environmental Limits

#### Operating Temperature:

Standard Models: 0 to 60°C (32 to 140°F)  
 Wide Temp. Models: -40 to 75°C (-40 to 167°F)

**Operating Humidity:** 5 to 95% RH

**Storage Temperature:** -40 to 85°C (-40 to 185°F)

**Power Requirements**

**Input Voltage:** 12 to 48 VDC

**Power Consumption:**

- NPort IA5150A: 12 to 48 VDC; 220 mA @ 12 VDC, 110 mA @ 24 VDC
- NPort IA5250A: 12 to 48 VDC; 255 mA @ 12 VDC, 130 mA @ 24 VDC
- NPort IA5250AI: 12 to 48 VDC; 250 mA @ 12 VDC, 125 mA @ 24 VDC
- NPort IA5250AI: 12 to 48 VDC; 290 mA @ 12 VDC, 150 mA @ 24 VDC
- NPort IA5450A: 12 to 48 VDC; 374 mA @ 12 VDC, 184 mA @ 24 VDC
- NPort IA5450AI: 12 to 48 VDC; 512 mA @ 12 VDC, 242 mA @ 24 VDC

**Regulatory Approvals**

**EMC:** CE (EN55022 Class A, EN55024), FCC Part 15 Subpart B Class A

**Safety:** UL508 (Pending)

**Hazardous Location:** UL/cUL Class 1 Division 2 Groups A, B, C and D (Pending)

**ATEX:** Class I, Zone 2 (Pending)

**EMS:**

- EN61000-4-2 (ESD), Level 3
- EN61000-4-3 (RS), Level 3
- EN61000-4-4 (EFT), Level 4
- EN61000-4-5 (Surge), Level 3
- EN61000-4-6 (CS), Level 3
- EN61000-4-8
- EN61000-4-11

**Shock:** IEC60068-2-27

**Freefall:** IEC60068-2-32

**Vibration:** IEC60068-2-6

**Reliability**

**Alert Tools:** Built-in buzzer and RTC (real-time clock)

**Automatic Reboot Trigger:** Built-in WDT (watchdog timer)

**Warranty**

**Warranty Period:** 5 years

**Details:** See [www.moxa.com/warranty](http://www.moxa.com/warranty)

**Pin Assignment**

**RS-232/422/485 DB9 male port**

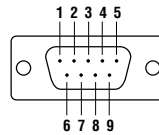

PIN	RS-232	RS-422/RS-485-4w	RS-485-2W
1	DCD	TxD-(A)	-
2	RXD	TxD+(B)	-
3	TXD	RxD+(B)	Data+(B)
4	DTR	RxD-(A)	Data-(A)
5	GND	GND	GND
6	DSR	-	-
7	RTS	-	-
8	CTS	-	-

**RS-422/485 Terminal Block Wiring**

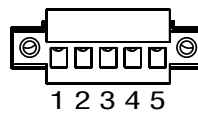

PIN	RS-422/RS-485-4w	RS-485-2w
1	TxD+(B)	-
2	TxD-(A)	-
3	RxD+(B)	Data+(B)
4	RxD-(A)	Data-(A)
5	GND	GND

**Dimensions (NPort IA5150A/IA5250A)**

**NPort IA5150A**  
**NPort IA5150AI**

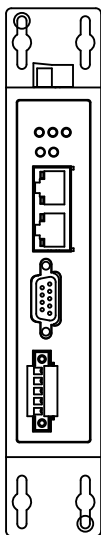

**NPort IA5250A**  
**NPort IA5250AI**

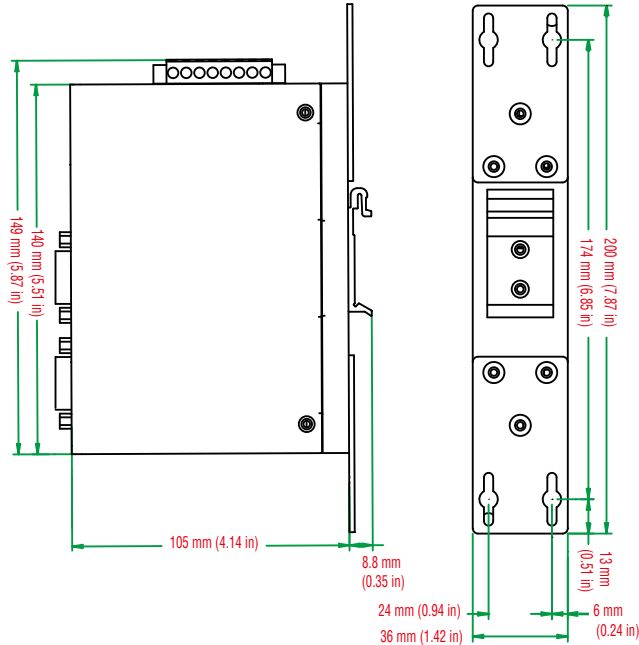
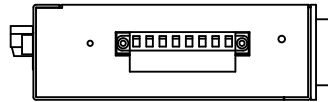
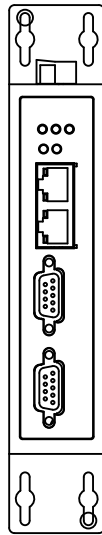

**Dimensions (NPort IA5450A)**

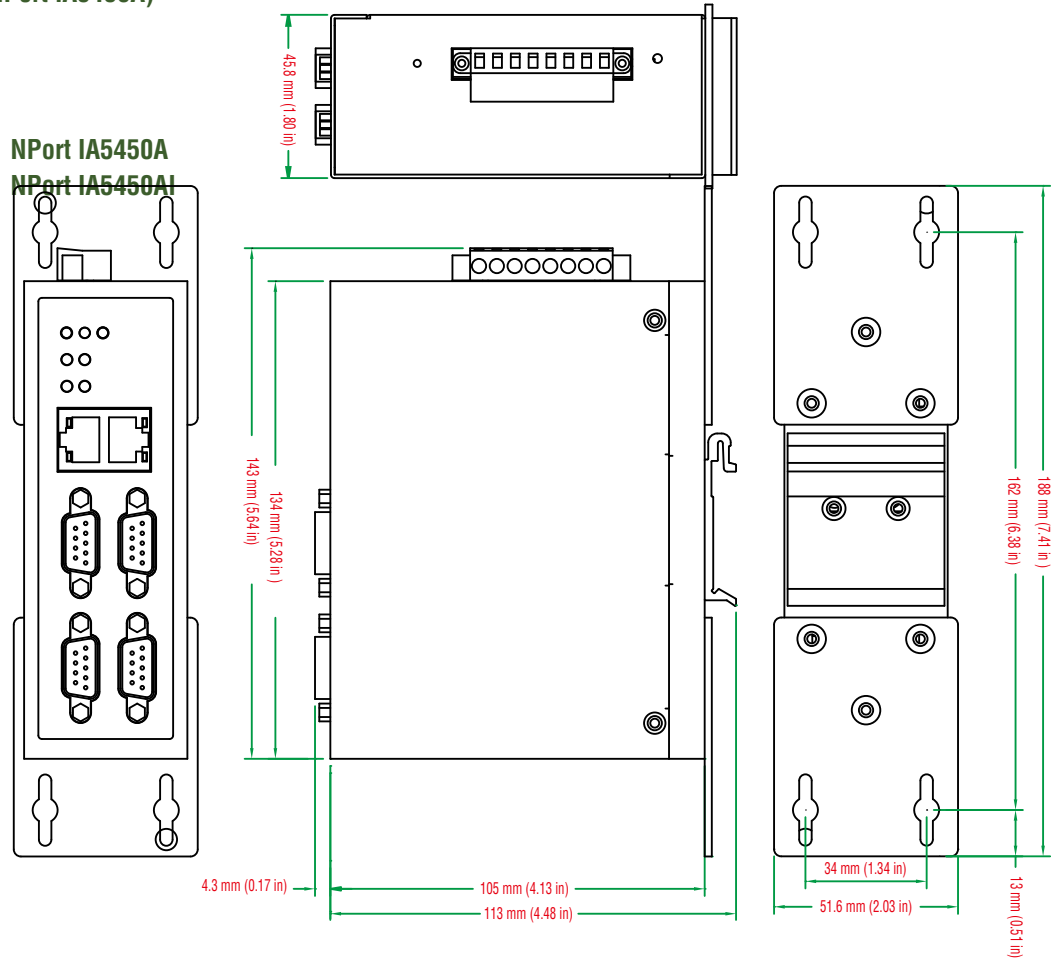

**Ordering Information**

**Available Models**

- NPort IA5150A:** 1-port RS-232/422/485 industrial automation device server with serial/LAN/power surge protection, two 10/100BaseT(X) ports with single IP, 0 to 60°C operating temperature
- NPort IA5150AI:** 1-port RS-232/422/485 industrial automation device server with serial/LAN/power surge protection, two 10/100BaseT(X) ports with single IP, 2 KV isolation, 0 to 60°C operating temperature
- NPort IA5250A:** 2-port RS-232/422/485 industrial automation device server with serial/LAN/power surge protection, two 10/100BaseT(X) ports with single IP, 0 to 60°C operating temperature
- NPort IA5250AI:** 2-port RS-232/422/485 industrial automation device server with serial/LAN/power surge protection, two 10/100BaseT(X) ports with single IP, 2 KV isolation, 0 to 60°C operating temperature
- NPort IA5450A:** 4-port RS-232/422/485 industrial automation device server with serial/LAN/power surge protection, two 10/100BaseT(X) ports with single IP, 0 to 60°C operating temperature
- NPort IA5450AI:** 4-port RS-232/422/485 industrial automation device server with serial/LAN/power surge protection, two 10/100BaseT(X) ports with single IP, 2 KV isolation protection, 0 to 60°C operating temperature
- NPort IA5150A-T:** 1-port RS-232/422/485 industrial automation device server with serial/LAN/power surge protection, two 10/100BaseT(X) ports with single IP, -40 to 75°C operating temperature
- NPort IA5150AI-T:** 1-port RS-232/422/485 industrial automation device server with serial/LAN/power surge protection, two 10/100BaseT(X) ports with single IP, 2 KV isolation, -40 to 75°C operating temperature
- NPort IA5250A-T:** 2-port RS-232/422/485 industrial automation device server with serial/LAN/power surge protection, two 10/100BaseT(X) ports with single IP, -40 to 75°C operating temperature
- NPort IA5250AI-T:** 2-port RS-232/422/485 industrial automation device server with serial/LAN/power surge protection, two 10/100BaseT(X) ports with single IP, 2 KV isolation, -40 to 75°C operating temperature
- NPort IA5450A-T:** 4-port RS-232/422/485 industrial automation device server with serial/LAN/power surge protection, two 10/100BaseT(X) ports with single IP, -40 to 75°C operating temperature
- NPort IA5450AI-T:** 4-port RS-232/422/485 industrial automation device server with serial/LAN/power surge protection, two 10/100BaseT(X) ports with single IP, 2 KV isolation protection, -40 to 75°C operating temperature

**Optional Accessories** (can be purchased separately)

- 8-contact screw-type terminal block:** Power inputs and relay output
- 3-contact screw-type terminal block:** For the NPort IA5150A's RS-422/485 port
- WK-36-01:** Wall mounting kit for the NPort IA5150A/IA5250A
- WK-51-01:** Wall mounting kit for the NPort IA5450A

**Package Checklist**

- NPort® IA5000A series device server
- Document and Software CD
- Quick Installation Guide (printed)
- Warranty Card